

## RESEARCH ARTICLE

### TWO-STAGE OSCILLATOR MECHANISM FOR OPERATING A RECIPROCATING PUMP

\*Nikhade, G. R., Patil, R.U. and Bansal, S. P.

Department of Mechanical Engineering, Shri Ramdeobaba College of Engineering and Management, Nagpur, India

#### ARTICLE INFO

##### Article History:

Received 07<sup>th</sup> May, 2013  
Received in revised form  
30<sup>th</sup> June, 2013  
Accepted 06<sup>th</sup> July, 2013  
Published online 23<sup>rd</sup> August, 2013

##### Key words:

Two-stage oscillator,  
Compound pendulum,  
Gravity shield,  
Reciprocating pump.

Copyright © 2013 Nikhade, *et al.*, This is an open access article distributed under the [Creative Commons Attribution License](https://creativecommons.org/licenses/by/4.0/), which permits unrestricted use, distribution, and reproduction in any medium, provided the original work is properly cited.

#### ABSTRACT

This paper presents the conceptual mechanism to run the reciprocating pump by the two-stage oscillator. It provides the energy required to lift the water from a tank placed approximately 2.5 meter below the ground level. Basic application of the mechanism will be for watering the garden which will be operated by means of opening and closing of entrance gate. Paper consists of basic concept, design of pump and two-stage oscillator mechanism and fabrication of the model.

#### INTRODUCTION

Two-stage oscillator is a compound pendulum in which energy is transferred from one pendulum to another. Once the pendulum is provided with some input, it keeps on oscillating for some time thus transferring the energy to the other pendulum. In the year 1999, Sir Veljko Milkovic invented the two-stage oscillator mechanism. It was a new concept at that time. The highlight of the mechanism was the amount of energy input proved to be less than the energy obtained. The statement seems to be hypothetical but this was explained by carrying out various kinds of experiments. Nebojša Simin explained the phenomenon of increasing the input energy by operation of the pendulum-lever system [1]. Sir Jovan Bebic and Lujbo Panic also developed a relation between output and input energy of the system and found that the system has efficiency greater than unity [2, 4]. Jovan Marjanovic discussed the theory of gravity machines [7, 8]. The logic of this theory was also used to explain the two-stage mechanical oscillator of Veljko Milkovic and pointed out a way to improve its behavior. He also stated that the pivot point should have some lag before moving up or down until pendulum comes in position such that its pivot point and bob move in opposite directions. Jovan Marjanovic analyzed the factors affecting the free energy of the pendulum and various other factors [9]. He concluded that output energy was solely based on the mass of the bob of pendulum.

The research done till now concentrated only on the working and the effectiveness of the mechanism. This paper presents the possibility of using this mechanism in real world application. Considering all of the advantages of the mechanism it was decided to use it for lifting water with the help of a reciprocating pump such that the input to the mechanism would be given with the help of entrance gate of the garden for watering the plants without electricity.

#### The Concept

The logic of two-stage oscillator is based on the concept of gravity shield as explained in the figure 1. Initially the shield is turned off and body with mass  $M$  is resting on the shield (Figure 1-a). Turning off the shield could also mean to move it aside and turning on to put it below the mass. In Figure 1-b, the shield is turned on and gravity doesn't have influence on mass  $M$ . It is easy to move the mass upward with a finger of the hand. Note that inertia of the mass still exists and some energy is still necessary to invest in order to push the mass in any direction.

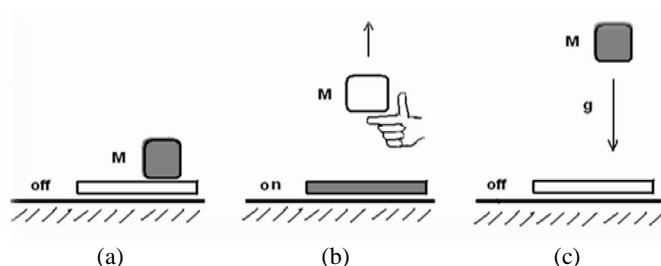

Figure 1. Concept of Gravity Shield

\*Corresponding author: Nikhade, G. R.

Department of Mechanical Engineering, Shri Ramdeobaba College of Engineering and Management, Nagpur, India

Once the mass comes to desired height, the shield is turned off again and the mass  $M$  will fall down. Obviously the mass  $M$  will transform all its potential energy into kinetic energy once it reaches the ground as shown in Figure 1-c. Instead of using hand for raising the mass upwards, simple gravity machine can be made as shown in Figure 2. After turning on the shield, as in Figure 2-b, the weight of mass  $m$  will be able to overcome inertia and to move bigger mass  $M$  upwards. After some period of time mass  $m$  will move down to its low position and mass  $M$  up to its high position. The shield is turned off again, as in Figure 2-c, and mass  $M$  will prevail the smaller mass  $m$  and fall down again as in Figure 2-a.

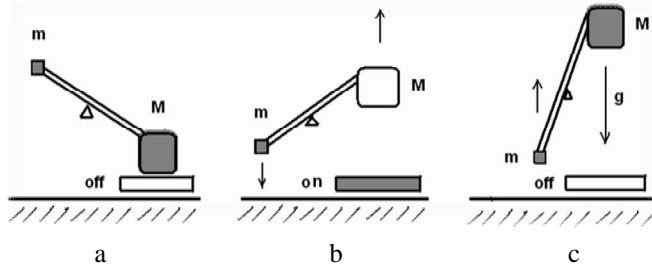

Figure 2. Gravity Shield effect with Lever

The artificial gravity effect can be created by using rotation and inertia. In this the pendulum resembles the gravity shield, such that its energy varies from horizontal to vertical axis. The work done by total vertical force acting at pivot point of the pendulum when the pendulum is at vertical axis is passed to the left side of the lever and this work is used to increase potential energy of mass on the other side of the lever as it goes upwards. Once the pendulum moves upwards, total vertical force will be less than force acting on the other side of the lever and thus lever will go down on the left side and up on the right. This up and down motion of the other end of lever can do some useful work as pumping water. The pivot point of the lever plays major role in the transfer of the energy and the displacement from pendulum side to other side of the lever. For obtaining large displacement, the lever can be divided into a ratio such that one side of the lever is longer than the other. Figure 3 shows the conceptual design of the two-stage oscillator.

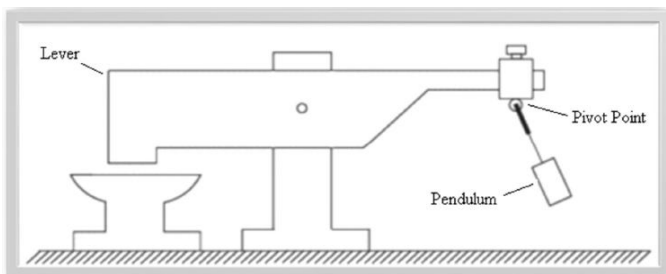
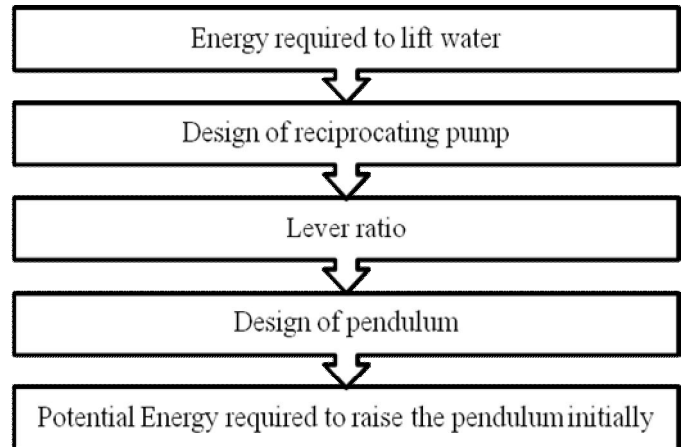

Figure 3: Conceptual Design of Two-Stage Oscillator

**Design of the system**

Any design process starts with its need defined in the real world. In gardens it is necessary to keep on watering the plants so that the greenery can be maintained. Considering the depleting resources of producing electricity, by employing this mechanism watering can be done without using electricity.

**Flowchart**



The above flowchart shows the steps involved in the design of whole system. In this process first the output required to lift the water from a particular height is calculated. Based on this output the pump was designed and then the input required by the system.

**Design of Reciprocating Pump**

For the design of the system, it is considered that the suction head is 25 meter.

Power required by reciprocating pump is given by following equation

$$P = \frac{g\rho AN(H_s + H_d)L}{60} \text{ watts} \tag{1}$$

where,  $\rho$  is the density of water,  $A$  is the cross-sectional area of reciprocating pump ( $m^2$ ),  $N$  is the speed of reciprocating pump (*strokes / min*),  $H_s$  is the suction head ( $m$ ),  $H_d$  is the delivery head ( $m$ ),  $L$  is the length of stroke ( $m$ )

Energy of reciprocating pump is given by

$$E_{out} = g\rho A(H_s + H_d)L \text{ Joule} \tag{2}$$

Pumps ideally will produce any head that is impressed on it. The maximum head is determined by the power available and the strength of the pump parts. Assuming diameter of pump as 50 mm and length of stroke as 80 mm.

Speed of the pump,

$$N = \frac{60}{T_p} \tag{3}$$

Swept Volume,

$$v = Al \tag{4}$$

Discharge,

$$Q = Nv \tag{5}$$

Minimum Thickness of cylinder,

$$t = \frac{PD}{2\sigma} \tag{6}$$

The various parameters related to pump were found from above equations are mentioned in Table 1.

**Table 1. Values of various parameters related to pump**

Parameter	Value
Energy for operating reciprocating pump ( $E_{out}$ )	3.854 Joule
Speed	45 strokes / min
Swept Volume	157.079 cc
Discharge	0.007068 m <sup>3</sup> / min
Minimum Thickness of cylinder	3 mm

The lever is most critical component in this mechanism, because the load on the other end is constantly changing due to suction and delivery strokes. The pivot point of the lever was such that it was divided in the ratio 3:1 and the actual length of the lever was taken as 590 mm.

**Design of Pendulum**

Mass of the bob plays as major role in deciding the input energy of the system and the potential energy required for starting the oscillations.

Energy transmitted through the lever

$$E_{in} = \frac{E_{out}}{\eta_{mech}} \tag{7}$$

where,  $E_{in}$  is the input energy, and  $\eta_{mech}$  is the transmission efficiency assumed to be 75 %.

Input energy is given by the following equation

$$E_{in} = F \times S \tag{8}$$

where, F is the force equal to the tension at pivot point and S is the displacement of the pivot.

Tension at the pivot point is given by following equation

$$T = M_p g (3 \cos(\varphi) - 2 \cos(\varphi_0)) \text{ Newton} \tag{9}$$

where,  $M_p$  is the mass of the pendulum,  $g$  is the acceleration due to gravity,  $\varphi$  is the angle of pendulum from its current position to the vertical axis, and  $\varphi_0$  is the angle of pendulum from its initial position to the current position

From the equation (8), it can be observed that energy is directly proportional to the product of displacement of the Pivot Point (S), mass of the Pendulum ( $M_p$ ) and the acceleration due to gravity (g). If the pendulum is dropped from position 2 as shown in Figure 4, then maximum input energy would be obtained.

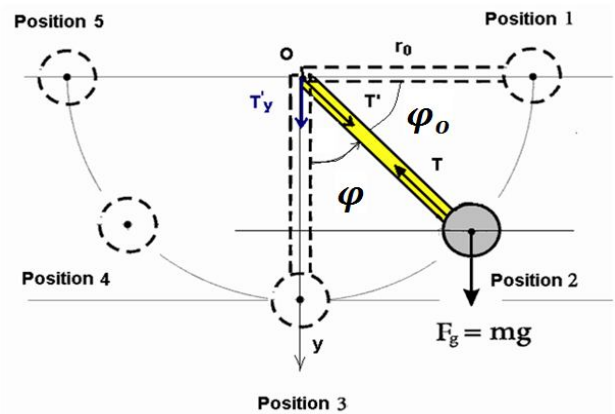

**Figure 4. Various positions of Pendulum**

The length of the pendulum depends on various parameters viz. stokes per revolution, swept area, centrifugal force.

**Potential Energy**

The energy required for starting the oscillation of the pendulum is equal to the potential energy for lifting the equivalent weight of pendulum from initial position to the final position as shown in figure 5, it is given by

$$P.E. = M_p g h$$

where,  $h$  is the lift of the pendulum

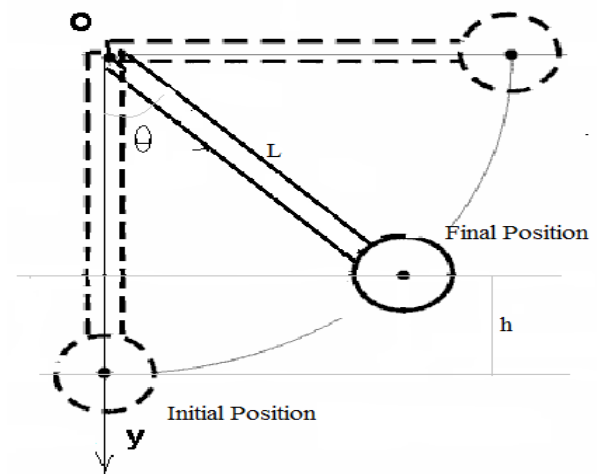

**Figure 5. Various positions of pendulum**

**Table 2. Calculated parameters related to mechanism**

Parameter	Value
Input energy ( $E_{in}$ )	8.072 Joule
Mass of bob ( $M_b$ )	16 kg
Height ( $h$ )	0.164 meter
Potential energy (P.E.)	25.744 Joule

**Experimentation**

The Figure 6 is the wireframe model of the system shows various components used for fabrication. Following steps explains the procedure for experimentation.

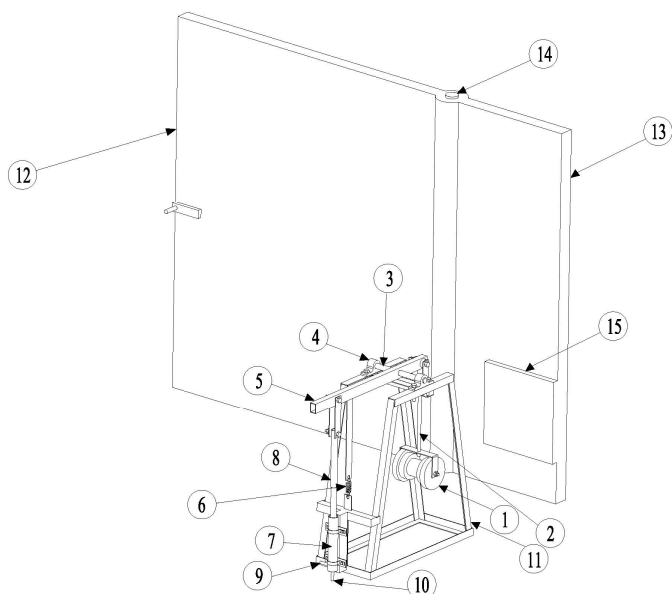

**Figure 6. Wireframe Model**

1. As the pendulum (1) starts oscillating, the conversion of the potential energy to kinetic energy and to potential energy starts occurring.
2. At extreme positions, the potential energy is maximum and at vertically downward position kinetic energy is maximum. Also when the pendulum moves towards any of its extreme positions, the effective downward force on the pendulum side of the lever (5) becomes lesser than that on the pump side.
3. As a result, pendulum side of lever moves up. Downward motion of the pump side of the lever gives the delivery stroke.
4. When the pendulum is at vertical position, the effective downward force on the pendulum side is more than that on the pump side. Hence this end of the lever goes up and suction stroke occurs. It should be noted that lever acts as the second pendulum and it oscillates about a shaft (3) which is supported by two pedestal bearings (4).
5. Oscillating motion of the lever is converted into reciprocating motion by pivoting the piston rod (8) to the lever instead of fixing it. The position of delivery valve (9) and suction valve (10) can be identified from the figure. The tank has to be kept below the suction valve.
6. In order to make the system work spontaneously a spring (6) has to be employed at the pump side of the lever. All these components are to be mounted on a frame (11).
7. Second part of the setup is the gate of the garden where the mechanism can be attached. For employing this mechanism, the gate has to be extended beyond its hinge (14). Let (12) be the entrance side of the gate and (13) be its extended side as shown in Figure 6.
8. On the extended side a magnet (15) is attached. Whenever the gate will be opened (assuming clockwise movement) the magnet would get closer to the pendulum. The moment the pendulum comes into its magnetic field it would get attracted to it. The magnetic flux of the magnet would be such that it holds the heavy bob of pendulum.
9. When the gate will be closed, the pendulum would get pulled by the magnet i.e. by the gate. The length of pendulum rod (2) is such that when the gate will be fully

closed the pendulum won't be able to reach the magnet. Due to this, the contact of the bob and magnet will brake and the heavy pendulum would fall and start oscillating.

10. This oscillatory motion of the pendulum helps in lifting the water up to the designed head. Thus, the system would operate whenever the gate will be opened and closed which is very frequent at places like gardens. In this way the purpose to watering the garden can be achieved without using any electricity and manpower. Fabricated model is as shown in Figure 7.



**Figure 7. Fabricated Model**

## RESULTS

The major testing parameters were the amount of energy actually required to be given to the pendulum and the discharge obtained from the pump. Along with this the other parameters were also tested and compared with the designed values as per Table 3.

**Table 3. Comparison of designed and actual values**

Parameters	Designed Value	Actual Value
Displacement of Pivot (S)	0.1 meter	0.03 meter
Angle Of Swing ( $\theta$ )		
•	50°	50°
•	0°	20°
•		
Minimum angle		
Input Energy per stroke ( $E_{in}$ )	13.459 Joule	8.072 Joule
Speed (N)	45 strokes/min	44 strokes/min
Discharge (Q)	7.068 lit/min	6.911 lit/min
Total Head (H)	6.55 meter	2.5 meter
Output Energy ( $E_{out}$ )	10.094 Joule	3.854 Joule
Transmission Efficiency ( $\eta_{mech}$ )	75 %	50.94 %

It was observed that if the input is given once, then the pendulum does 8 working oscillations for operating the pump. Input the energy given to the system is equal to the potential energy required to raise the pendulum and is equal to 25.744 J. Also for each working oscillation of the pendulum output energy is 8.072 J. So, for 8 oscillations the total energy obtained is equal to

$$(E_{in})_{total} = \sum_{i=0}^7 M_B g (3 - 2 \cos(20 + 4.28i)) S = 52.188 \text{ Joule}$$

This proves that the output energy is more than the input energy and hence it can be termed as an over unity machine. Also the frequency of oscillations of the pendulum was observed to be 0.733 Hz and the discharge obtained was 2.269 lit/min. Thus in one push, 0.4127 lit of water was discharged by the pump.

## CONCLUSION AND DISCUSSION

Based on the results obtained after testing the model, it was quite obvious that the amount of energy to be given to the system is less than the amount of energy obtained from the system. Actually the system takes its energy from the nature i.e. gravity. So if, along with the input energy, the energy from the nature is also considered then the efficiency of the system would be less than 100 % and if only input energy is considered then its efficiency would be greater than 100 % for certain period of time. Also it was concluded that if the pivot point of the pendulum is not allowed to undergo large displacement, then the pendulum can be kept on oscillating for larger amount of time, though this would mean that the complete energy obtained at the pump end of the lever is not utilized. But if the oscillating motion of the pendulum is maintained, then frequency of giving the input to the system

would become lower. This would fetch the output from the system for longer period of time. The fact that, in such case, only initial cost would be high and no operating cost makes it very much advantageous. Apart from this the different applications of the system were identified. This system can be used in gym where different equipment can be attached to it for raising the water to higher head. Another important application of the mechanism is in farms where the problem of electricity is always present. The mechanism can be of great use in such conditions as it does not require any electricity.

## Acknowledgement

The authors would like to express their appreciation to Nikhil Bansal, Harihar Mishra, Rajat Deshpande, Nitesh Sukhwani, the students of Mechanical Engineering Dept. for their effort to complete this project.

## REFERENCES

- [1] Nebojša, Simin 2007. Free Energy of the Oscillating Pendulum-lever System. Alekse Šantica 47, 21000, Novi Sad, Serbia: 1-7
- [2] Jovan Marjanovic 2007. Analysis of the Influence of the Centrifugal Force during Operation of the Two-stage Mechanical Oscillator. Novi Sad, Serbia: 1-3
- [3] Jovan Marjanovic 2007. Measuring the Ratio of Output and Input Energy of the Two-stage Mechanical Oscillator. Novi Sad, Serbia: 1-3
- [4] Ljubo Panic 2008. On the Track of the Energy Surplus of a two-stage Mechanical Oscillator. Novi Sad, Serbia: 1-4
- [5] Jovan Marjanovic 2008. Keys of Understanding Gravity Machines of Veljko Milkovic. Novi Sad, Serbia: 1-19
- [6] Jovan Marjanovic 2008. Mechanical Feedback Loop Problems and Possible Solutions for the Two-Stage Oscillator of Veljko Milkovic. Novi Sad, Serbia: 2-39
- [7] Jovan Marjanovic 2010. Theory of Gravity Machines. Veljko Milkovic Research & Development Centre, Novi Sad, Serbia: 1-10
- [8] Jovan Marjanovic 2010. Angular Momentum, Parametric Oscillator and Over Unity. Veljko Milkovic Research & Development Centre, Novi Sad, Serbia: 1-24
- [9] Jovan Marjanovic 2011. The Secret of Free Energy from the Pendulum. Veljko Milkovic Research & Development Centre, Novi Sad, Serbia: 1-12
- [10] Jovan Marjanovic 2012. Recommendations for Construction and Efficiency Measuring of the Two-stage Mechanical Oscillator. Veljko Milkovic Research & Development Centre, Novi Sad, Serbia: 1-19

\*\*\*\*\*